

CAROLINA CHAIR & TABLE COMPANY

ASSEMBLY INSTRUCTIONS



Item # 195

Thank you for purchasing a Carolina Chair & Table Company product. This product has been designed for easy assembly and is constructed for durability. Please take the time to read and follow the assembly instructions carefully. If a part or hardware is missing or you have any difficulties in assembling this product, please contact us Toll-Free at 1-800-228-3876

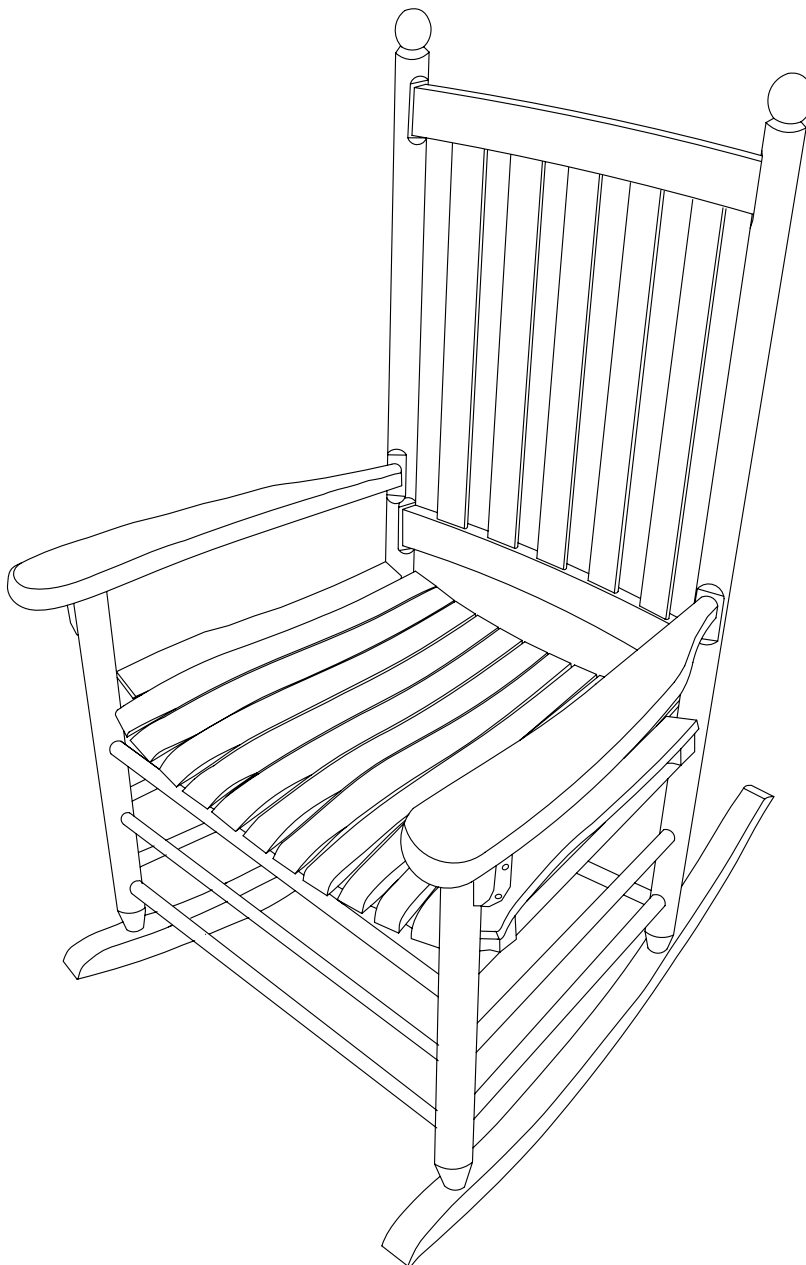

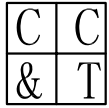

CAROLINA CHAIR & TABLE COMPANY

BEFORE ASSEMBLY

Be sure to check all packing material carefully for small parts which may have come loose inside the carton during shipment. Please separate, identify, and count all parts and metal hardware. Compare with part list to be sure all parts are present.

IMPORTANT NOTE:

- Place all wooden parts on a clean and smooth surface such as a rug or carpet to avoid the parts from being scratched.
- Remove all wrapping material.
- DO NOT tighten all screws and bolts until completely assembled.
- Keep all hardware parts out of reach of children.

ASSEMBLY TOOLS REQUIRED

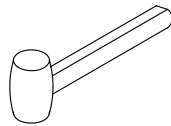

Rubber Mallet

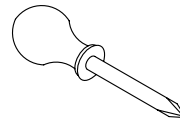

Philip Head
Screw Driver

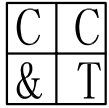

NOT INCLUDED



CAROLINA CHAIR & TABLE COMPANY

PART LIST

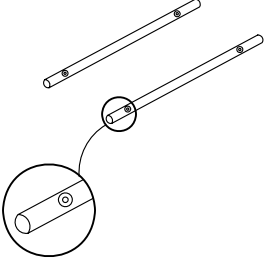
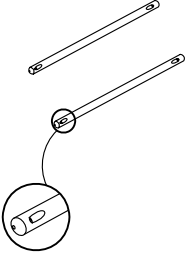
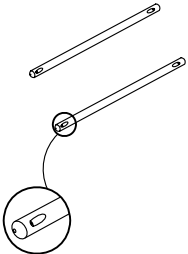
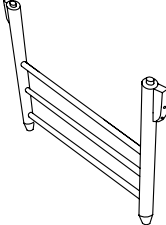
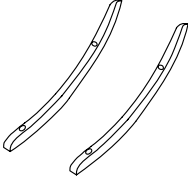
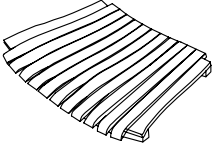
When unpacking, please be careful not to discard any parts with the packaging.
Before continuing, please make sure you have the following parts:

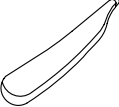
No	Description	Qty	Sketch	No	Description	Qty	Sketch
A	Chair Back Panel	1		B	Long Stretchers	2	
C	Medium Stretchers	2		D	Short Stretchers	2	
E	Front Leg Frame	1		F	Runners	2	
G	Seat	1		H	Arm Rest - Left	1	
I	Arm Rest - Right	1					

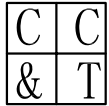

CAROLINA CHAIR & TABLE COMPANY

HARDWARE LIST

Before continuing, please make sure you have the following hardware:

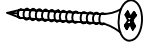
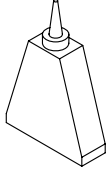
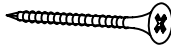
No	Description	Qty	Sketch	No	Description	Qty	Sketch
a	Pan Head Screws (M4x32MM)	6		c	Glue	1	
b	Pan Head Screws (M4x38MM)	14					

Step 1:

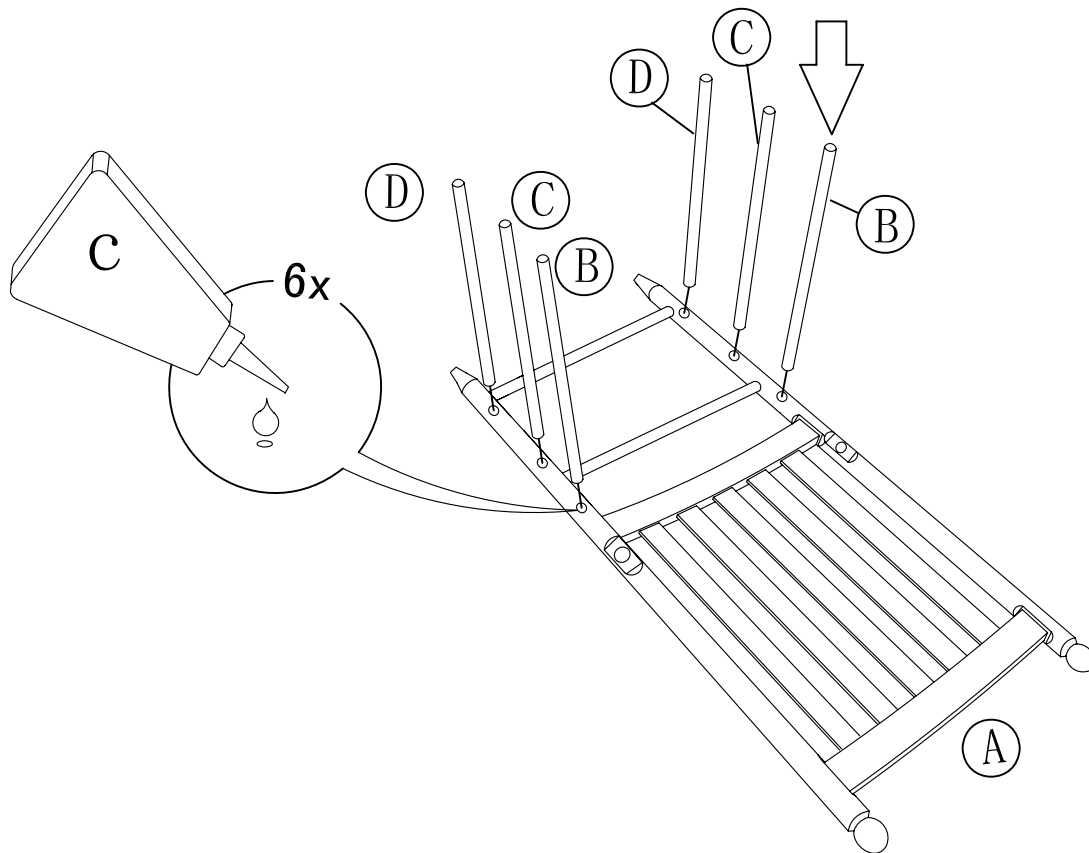

Please note pre-drilled screw holes on stretchers should be facing down towards Runners.

Step 2:

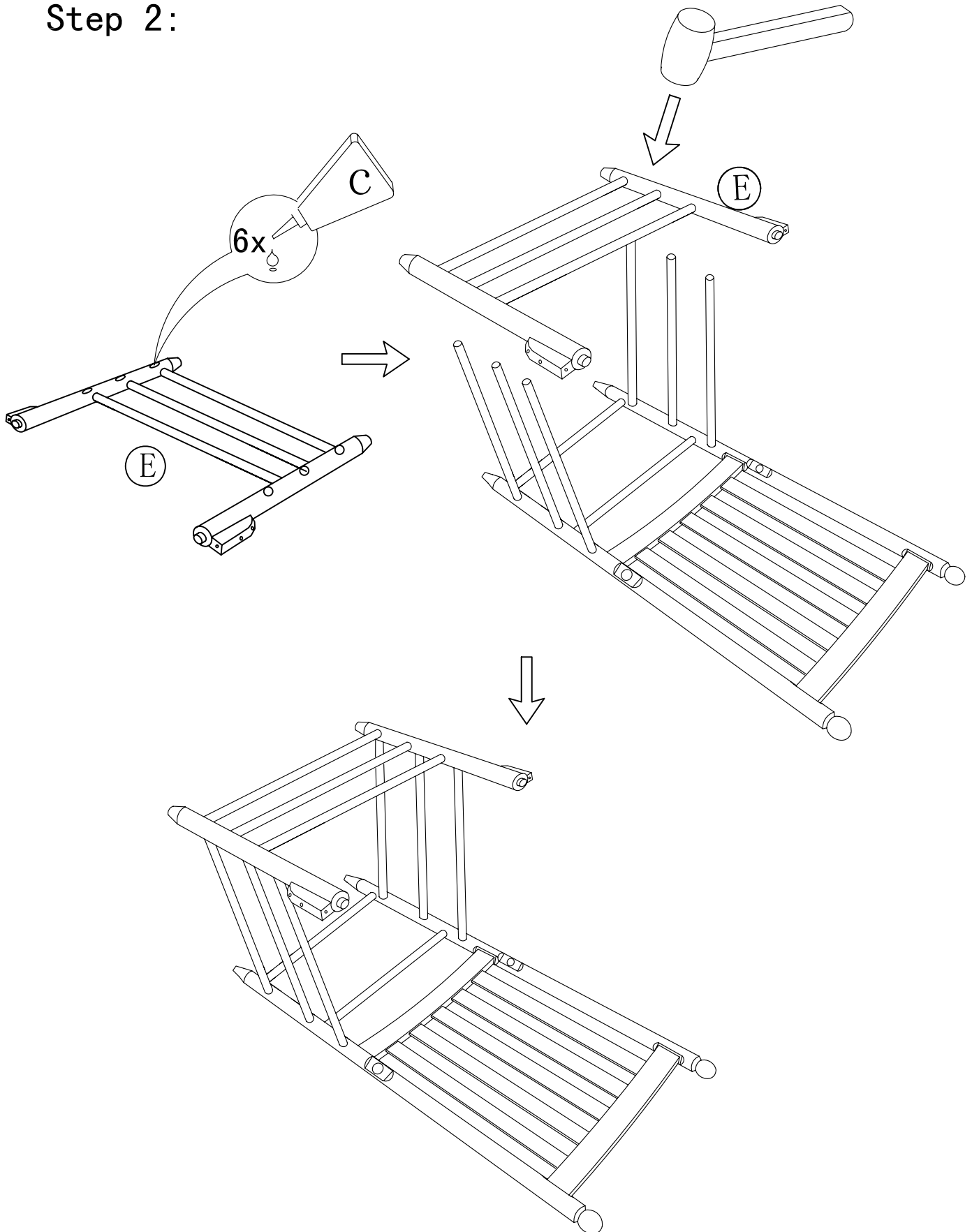

Step 3:

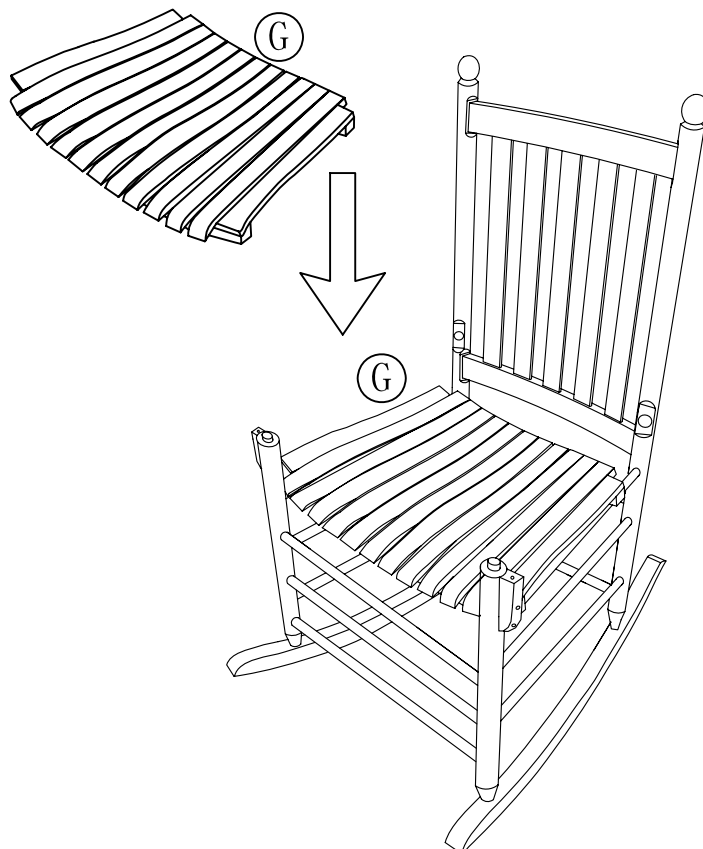
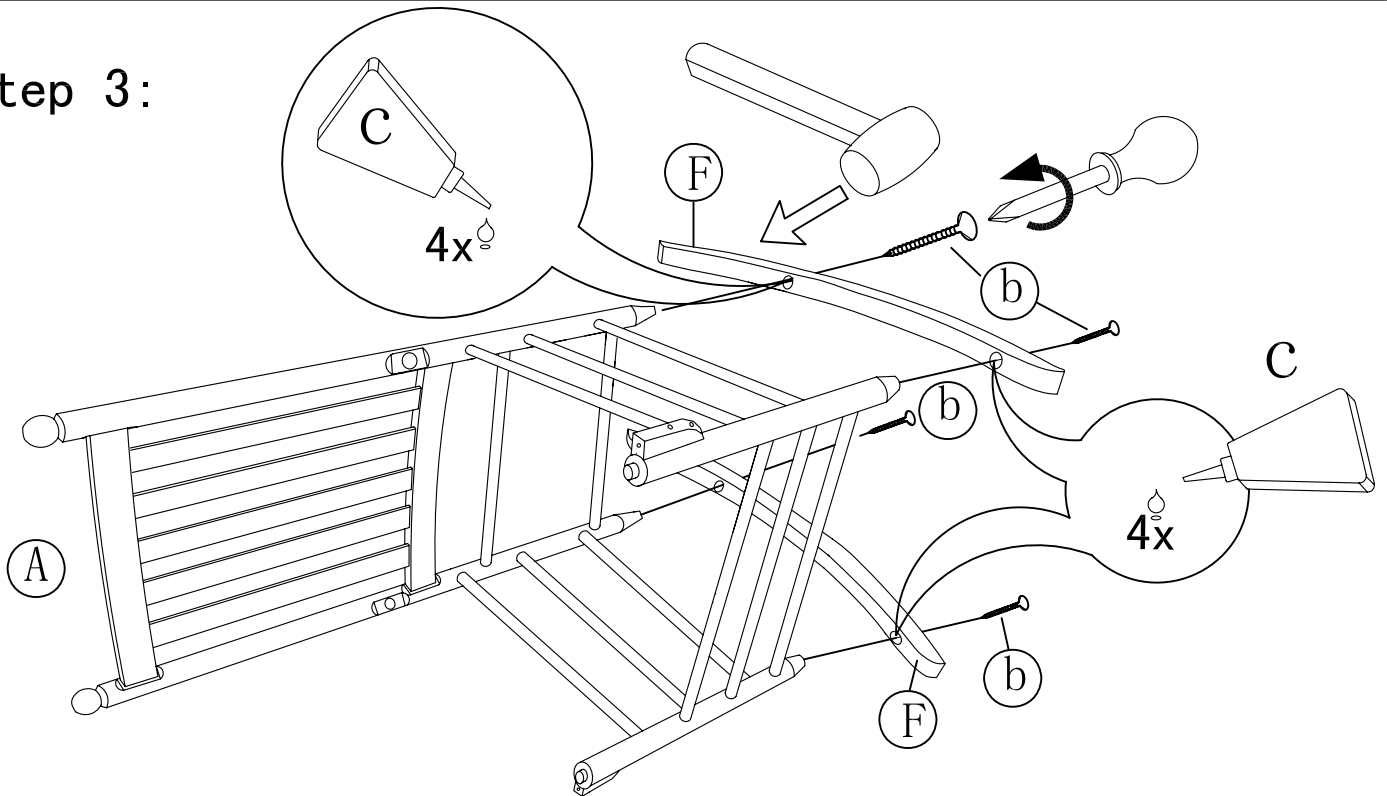

Step 4:

